

Article number: 204350M16200D1TK
 Description: E+G levelling foot
 GN 43-50-M16-200-D1-TK
 Note: TK With nut, Wrench flat at the bottom

Measures

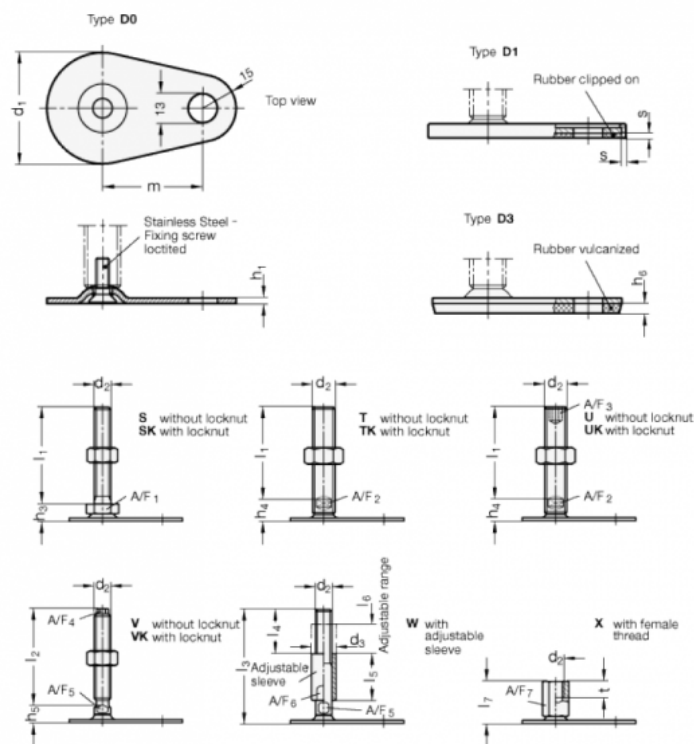

A/F2 = 12	s = 2
d1 = 50	
d2 = M16	
h1 = 2.5	
h4 = 17	
h6 =	
L1 = 200	
m = 45	